

ATXP-N FTXP20-35N

THE " → " MARK SHOWS THE PIPING DIRECTION.

REQUIRED SPACE FOR SERVICE AND VENTILATION

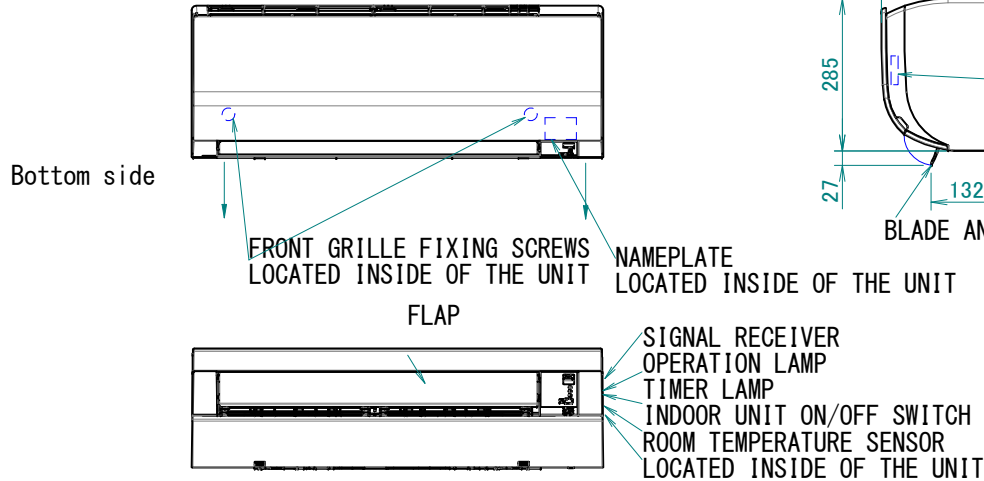
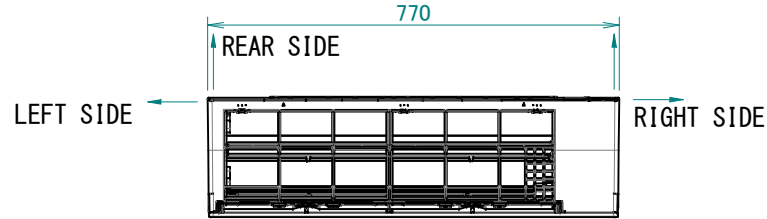

INCLUDING MOUNTING PALTE

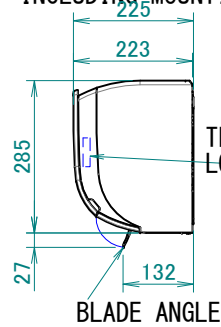

TERMINAL BLOCK WITH EARTH TERMINAL
LOCATED INSIDE OF THE UNIT

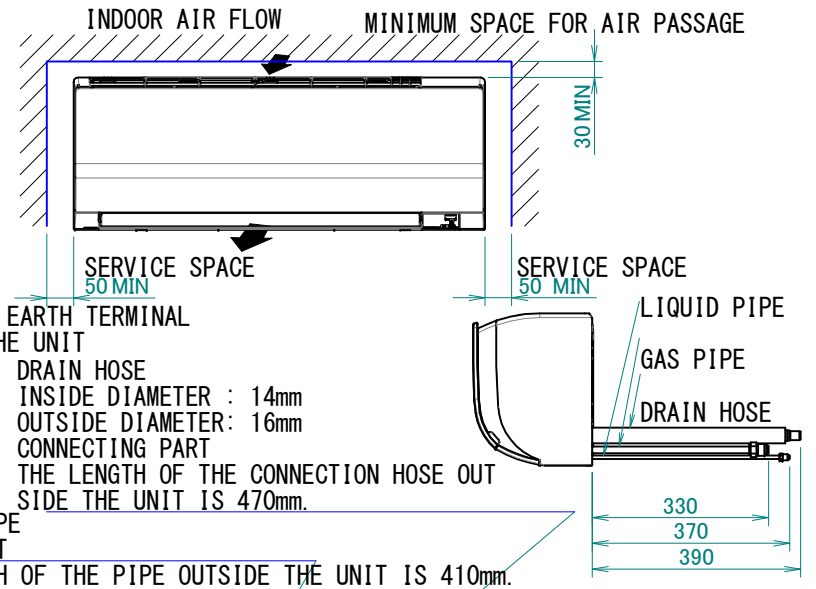

LIQUID PIPE
Ø6.4mm CUT
THE LENGTH OF THE PIPE OUTSIDE THE UNIT IS 410mm.

GAS PIPE
Ø9.5mm CUT
THE LENGTH OF THE PIPE OUTSIDE THE UNIT IS 360mm.

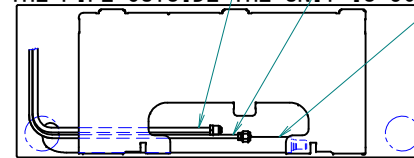

SIGNAL TRANSMITTER

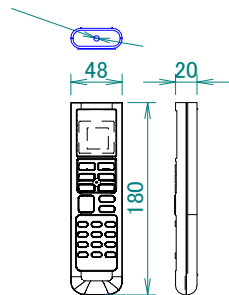

BLADE ANGLE

UP/DOWN (AUTOMATIC)

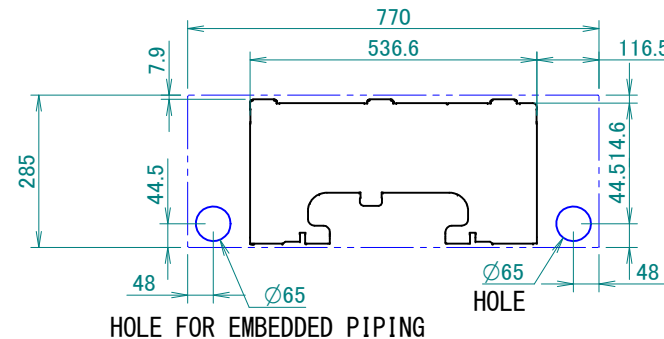
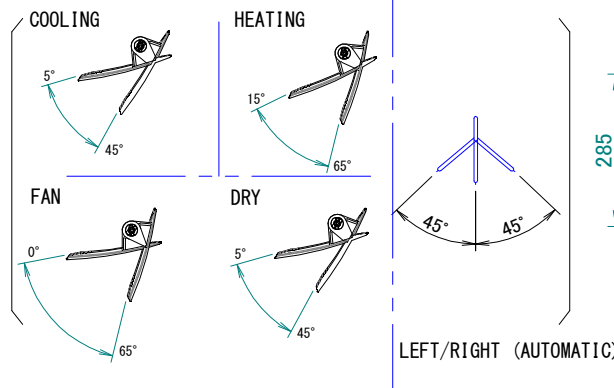

WIRELESS REMOTE CONTROL
(ARC480A78)

STANDARD LOCATION OF HOLES IN THE WALL

3D144255